

GAS SALAMANDER BROILER

QUEST Model QSB

With efficient infrared gas burners, the QUEST QSB has a 10 second warm up time and distributes even heat. Stainless steel sides, top and front are standard construction. The heavy-duty QSB comes in three standard sizes. This unit can be mounted on a range, wall or counter and is easily serviced from the front.



QSB 36
MODEL ILLUSTRATED

Product Features

- Heavy duty roll out rack
- Throttles to extremely low heat
- Powerful heat on high setting
- Stainless steel front and ends standard
- Rapid heat-up time – 10 seconds, full heat – 2 minutes
- Two burners, each with accurate temperature control Hi-Low valves
- Versatile and durable

Optional Features

- Available in 36" (914 mm), 24" (610 mm) and 18" (457 mm) widths
- SS under panel
- Flexible gas connector kit
- Counter mount kit
- Range mount kit
- Wall mount kit
- Extended wall mount kit

Quest- Gas Salamander Broiler

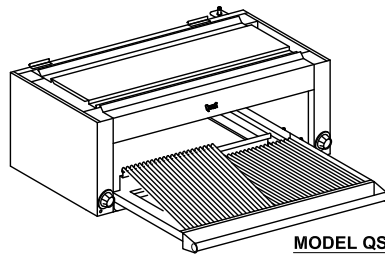

**MODEL QSB-36
SHOWN**

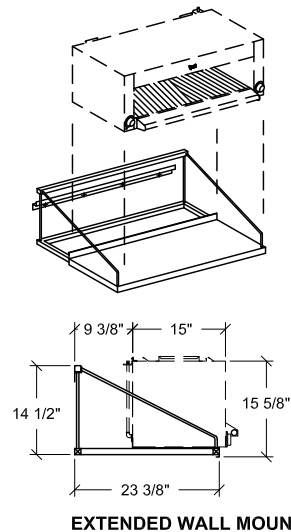
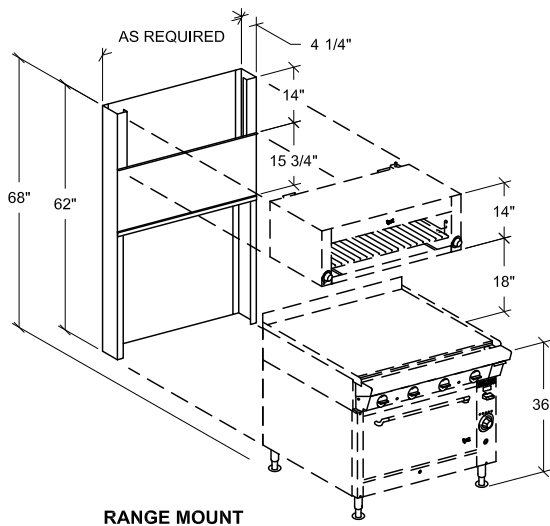
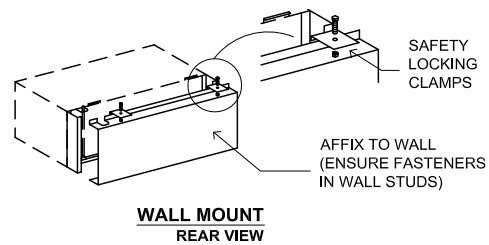
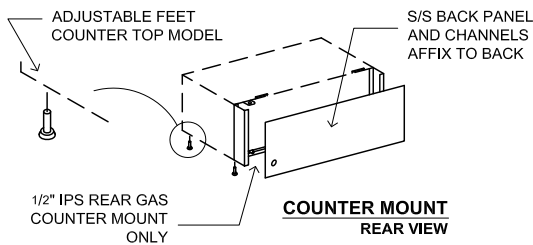
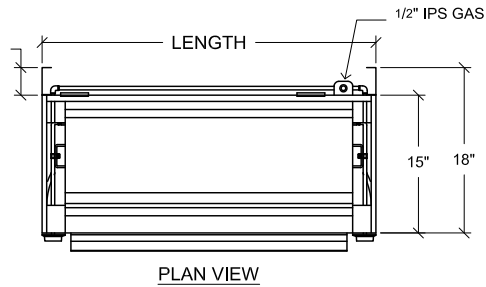
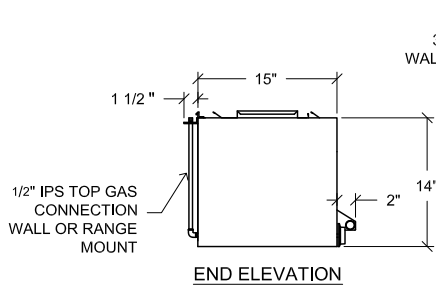

MODEL	WIDTH (mm)	DEPTH (mm)	BODY HEIGHT (mm)	BTU'S	GAS LINE	SHIPPING WEIGHT	
						LBS	KGS
QSB 18	18" (457)	15" (381)	14 3/4" (375)	21,000	1/2" (13)	95	43
QSB 24	24" (610)	15" (381)	14 3/4" (375)	28,000	1/2" (13)	110	50
QSB 36	36" (914)	15" (381)	14 3/4" (375)	49,000	1/2" (13)	145	66

NOTE: Dimensions are accurate at time of publication but subject to change without notice. If sizes are critical consult the factory.



QUEST Metal Products Limited
 889 Erin St, Winnipeg, MB R3G 2W6
 Tel: 204.786.2403 Fax: 204.783.7598
 Email: sales@questmp.ca

Distributed in Canada by:
 Russell Food Equipment Ltd.
russellfood.ca